



LED505-66-60



TECHNICAL DATA

High Power LED Array, 60 chips InGaN

LED505-66-60 is a wide viewing and extremely high output power illuminator assembled with a total of 60 high efficiency InGaN diode chips, mounted on a metal stem TO-66 with AlN ceramics and covered with double coated clear silicone and epoxy resin.

These devices are designed for high current operation with proper heat sinking to improve thermal conductive efficiency.

Specifications

- Structure: InGaN, 60 LED chips
- Peak Wavelength: 505 nm
- Optical Output Power: 60 mW
- Package: TO-66 stem with AlN
- Lens: clear silicone and epoxy resin

Absolute Maximum Ratings (T_A=25°C)

Item	Symbol	Value	Unit
Power Dissipation	P _D	7.8	W
Forward Current	I _F	400	mA
Pulse Forward Current * ¹	I _{FP}	2000	mA
Reverse Voltage	V _R	50	V
Operating Temperature	T _{opr}	-30 ... +80	°C
Storage Temperature	T _{stg}	-30 ... +110	°C
Soldering Temperature * ²	T _{sol}	240	°C

*¹ duty = 1%, pulse width = 1 μs

*² must be completed within 3 seconds at 260°C

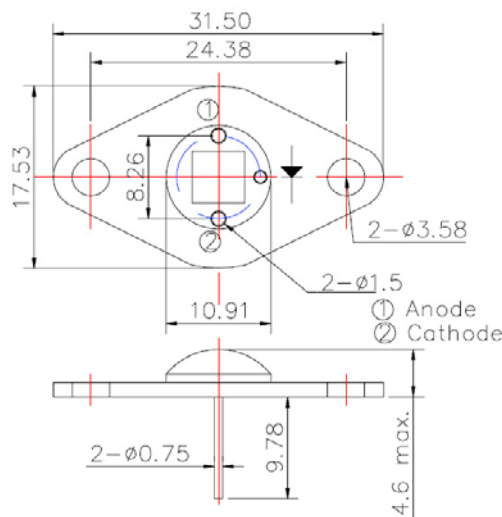

(Unit: mm)

Electro-Optical Characteristics

Item	Symbol	Condition	Min.	Typ.	Max.	Unit
Peak Wavelength	λ _P	I _F = 240 mA	495	505	515	nm
Half Width	Δλ	I _F = 240 mA	-	30	-	nm
Total Radiated Power	P _O	I _F = 240 mA	-	60	-	mW
Radiant Intensity	I _E	I _F = 240 mA	-	10	-	mW/sr
Brightness	I _V	I _F = 240 mA	-	4.5	-	cd
Forward Voltage	V _F	I _F = 240 mA	-	18.5	-	V
Reverse Voltage	V _R	I _R = 10 μA	30	-	-	V
Viewing Half Angle	Θ _{1/2}	I _F = 240 mA	-	±60	-	deg.

Heat Sink is required, to keep the LED at ≤60 °C.

Note: The above specifications are for reference purpose only and subjected to change without prior notice.



Precaution for Use

1. Cautions

- This high power LED must be cooled!
- DO NOT look directly into the emitting area of the LED during operation!



NOTE
LED
MUST BE COOLED

2. Soldering Conditions

- DO NOT apply any stress to the lead particularly when heat.
- After soldering the LEDs should be protected from mechanical shock or vibration until the LEDs return to room temperature.
- When it is necessary to clamp the LEDs to prevent soldering failure, it is important to minimize the mechanical stress on the LEDs.

3. Static Electricity

- The LEDs are very sensitive to Static Electricity and surge voltage. So it is recommended that a wrist band and/or an anti-electrostatic glove be used when handling the LEDs.
- All devices, equipment and machinery must be grounded properly. It is recommended that precautions should be taken against surge voltage to the equipment that mounts the LEDs.



4. Heat Generation

- Thermal design of the end product is of paramount importance. Please consider the heat generation of the LED when making the system design. The coefficient of temperature increase per input electric power is affected by the thermal resistance of the circuit board and density of LED placement on the board, as well as other components. It is necessary to avoid intense heat generation and operate within the maximum ratings given in the specification.
- The operating current should be decided after considering the ambient maximum temperature of LEDs.

5. Storage

- The LEDs should be stored at 30°C or less and 60%RH or less after being shipped and the storage life limits are 3 months. If the LEDs are stored for 3 months or more, they can be stored for a year in a sealed container with nitrogen atmosphere and moisture absorbent material.
- Please avoid rapid transitions in ambient temperature, especially in high humidity environments where condensation can occur.